

**Color CAMM1**  
by ROLAND DIGITAL GROUP

---

**PNC-5000**  
**USER'S MANUAL**

**For the USA**

**FEDERAL COMMUNICATIONS COMMISSION  
RADIO FREQUENCY INTERFERENCE  
STATEMENT**

This equipment has been tested and found to comply with the limits for a Class B digital device, pursuant to Part 15 of the FCC Rules.

These limits are designed to provide reasonable protection against harmful interference in a residential installation. This equipment generates, uses, and can radiate radio frequency energy and, if not installed and used in accordance with the instructions, may cause harmful interference to radio communications.

However, there is no guarantee that interference will not occur in a particular installation.

If this equipment does cause harmful interference to radio or television reception, which can be determined by turning the equipment off and on, the user is encouraged to try to correct the interference by one or more of the following measures:

- Reorient or relocate the receiving antenna.
- Increase the separation between the equipment and receiver.
- Connect the equipment into an outlet on a circuit different from that to which the receiver is connected.
- Consult the dealer or an experienced radio/TV technician for help.

Unauthorized changes or modification to this system can void the users authority to operate this equipment.

The I/O cables between this equipment and the computing device must be shielded.

**NOTICE**

**Grounding Instructions**

Do not modify the plug provided - if it will not fit the outlet, have the proper outlet installed by a qualified electrician.

Check with qualified electrician or service personnel if the grounding instructions are not completely understood, or if in doubt as to whether the tool is properly grounded.

Use only 3-wire extension cords that have 3-prong grounding plugs and 3-pole receptacles that accept the tool's plug.

Repair or replace damaged or worn out cord immediately.

**Operating Instructions**

**KEEP WORK AREA CLEAN.** Cluttered areas and benches invites accidents.

**DON'T USE IN DANGEROUS ENVIRONMENT.** Don't use power tools in damp or wet locations, or expose them to rain. Keep work area well lighted.

**DISCONNECT TOOLS** before servicing; when changing accessories, such as blades, bits, cutters, and like.

**REDUCE THE RISK OF UNINTENTIONAL STARTING.** Make sure the switch is in off position before plugging in.

**USE RECOMMENDED ACCESSORIES.** Consult the owner's manual for recommended accessories. The use of improper accessories may cause risk of injury to persons.

**NEVER LEAVE TOOL RUNNING UNATTENDED.**  
**TURN POWER OFF.** Don't leave tool until it comes to a complete stop.

**For Canada**

**CLASS B NOTICE**

This digital apparatus does not exceed the Class B limits for radio noise emissions set out in the Radio Interference Regulations of the Canadian Department of Communications.

**CLASSE B AVIS**

Cet appareil numérique ne dépasse pas les limites de la classe B au niveau des émissions de bruits radio - électriques fixés dans le Règlement des signaux parasites par le ministère canadien des Communications.



KEEP HANDS AWAY WHEN CUTTING TOOL IS IN MOTION.  
REGARDEZ BIEN OÙ VOUS METTEZ LES MAINS LORSQUE L'OUTIL DE DECOUPE FONCTIONNE.



**ROLAND DG CORPORATION**

1227 Ohkubo-cho, Hamamatsu-shi, Shizuoka-ken, JAPAN 432

MODEL NAME : See the MODEL given on the rating plate.

RELEVANT DIRECTIVE : EC MACHINERY DIRECTIVE (89/392/EEC)

EC LOW VOLTAGE DIRECTIVE (73/23/EEC)

EC ELECTROMAGNETIC COMPATIBILITY DIRECTIVE (89/336/EEC)

YEARS OF  
MANUFACTURE

1996

**WARNING**

This is a Class A product. In a domestic environment this product may cause radio interference in which case the user may be required to take adequate measures.

Thank you very much for purchasing the <Color CAMM> Model PNC-5000.

- To ensure correct and safe usage with a full understanding of this product's performance, please be sure to read through this manual completely and store it in a safe location.
- Unauthorized copying or transferal, in whole or in part, of this manual is prohibited.
- The contents of this operation manual and the specifications of this product are subject to change without notice.
- The operation manual and the product have been prepared and tested as much as possible. If you find any misprint or error, please inform us.

## Table of Contents

<b>Typographic Conventions</b> .....	<b>2</b>
<b>▲ To Ensure Safe Use</b> .....	<b>2</b>
<b>▲ About the Labels Affixed to the Unit</b> .....	<b>2</b>
To Ensure Correct Use .....	<b>2</b>
<b>1 Checking Supplied Items</b> .....	<b>3</b>
<b>2 Part Names and Functions</b> .....	<b>3</b>
2-1 Front View .....	<b>3</b>
2-2 Rear View .....	<b>3</b>
2-3 Operation Panel .....	<b>4</b>
<b>3 Set-up and Connections</b> .....	<b>5</b>
<b>4 What the PNC-5000 Can Do</b> .....	<b>5</b>
<b>5 Basic Operation</b> .....	<b>6</b>
5-1 DIP Switch Settings .....	<b>6</b>
5-2 Powering On .....	<b>6</b>
5-3 Installing/Removing a Blade .....	<b>7</b>
5-4 Installing a Ribbon Cartridge .....	<b>8</b>
5-5 Loading/Removing the Material .....	<b>9</b>
5-6 Downloading Printing/Cutting Data .....	<b>9</b>
5-7 Pausing Operations .....	<b>10</b>
5-8 Removing and Reloading a Printed Material for Cutting .....	<b>10</b>
5-9 Cutting Test to Check Cutter Force .....	<b>11</b>
5-10 Performing a Self-test .....	<b>11</b>
5-11 Powering Off .....	<b>11</b>
<b>6 Printing and Cutting Samples</b> .....	<b>12</b>
<b>7 About the Printing/Cutting Area</b> .....	<b>13</b>
<b>8 About the Blade</b> .....	<b>13</b>
<b>9 Care and Maintenance</b> .....	<b>14</b>
<b>10 What to Do If...</b> .....	<b>14</b>
<b>11 Specifications of PNC-5000</b> .....	<b>17</b>







# Typographic Conventions

This manual uses typographic conventions which are outlined at the right.

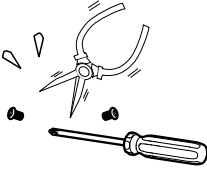
▲ This indicates a point requiring particular care to ensure safe use of the product.

- ▲ DANGER** : Failure to heed this message will result in serious injury or death.
- ▲ WARNING** : Failure to heed this message may result in serious injury or death.
- ▲ CAUTION** : Failure to heed this message may result in minor injury.
- NOTICE** : Indicates important information to prevent machine breakdown or malfunction and ensure correct use.
-  : Indicates a handy tip or advice regarding use.

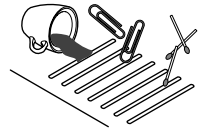
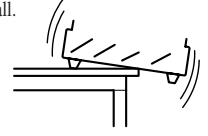
## ▲ To Ensure Safe Use

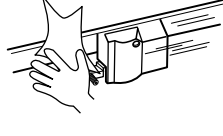
<p><b>▲ WARNING</b> Never disassemble or modify this product.</p> 	<p><b>▲ CAUTION</b> Handle the power cord with care.</p> <p>Do not step on or damage the power cord, or allow heavy objects to be placed atop it. Failure to heed may result in electrocution or fire.</p> 	<p><b>▲ CAUTION</b> Ensure the safety of the area around the platen before switching on the power.</p> <p>The carriage moves simultaneously when the power is switched on.</p> 	<p><b>▲ CAUTION</b> When pulling the power cord from an electrical socket, be sure to grip the plug.</p> 	
<p><b>▲ CAUTION</b> Do not allow liquids, metal objects or flammables inside the machine.</p> <p>Fire or breakdown may result.</p> 	<p><b>▲ CAUTION</b> Do not install in an unstable or high location.</p> <p>Do not install the machine on the edge of a table, or it may fall.</p> 	<p><b>▲ CAUTION</b> Handle the blade with care.</p> 	<p><b>▲ CAUTION</b> Do not inadvertently allow the hands, hair, or necktie near the carriage while in operation.</p> 	<p><b>▲ CAUTION</b> Do not place hands near the platen while in operation.</p> 

## ▲ About the Labels Affixed to the Unit

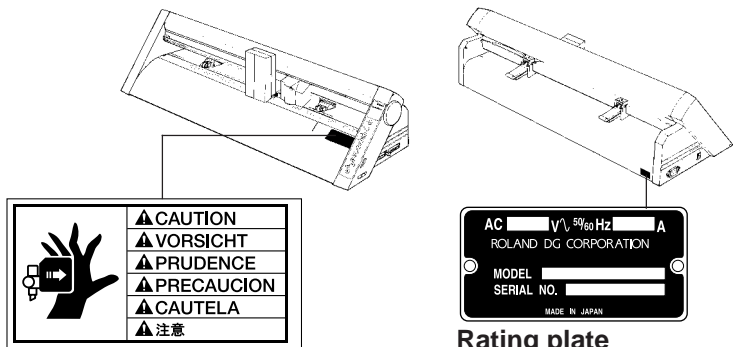

These labels are affixed to the body of this product. The following figure describes the location.

**Do not allow the hands near the platen while in operation.**

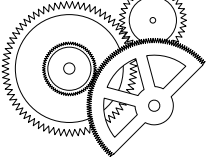

Rating plate

## To Ensure Correct Use

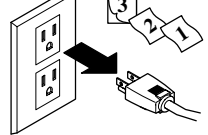
<p><b>NOTICE</b></p> <p>This product is a precision instrument and must be handled with care.</p> 	<p><b>NOTICE</b></p> <p>Do not install in an area subject to dust, high humidity or poor ventilation.</p> 	<p><b>NOTICE</b></p> <p>Do not connect to an AC outlet that supplies other than the specified voltage.</p> <table border="1" style="width: 100%; text-align: center;"> <tr> <td>100 V</td> <td>117 V</td> <td>220 V</td> </tr> <tr> <td></td> <td></td> <td></td> </tr> <tr> <td>240 V</td> <td>240 V</td> <td></td> </tr> <tr> <td></td> <td></td> <td></td> </tr> </table>	100 V	117 V	220 V				240 V	240 V					<p><b>NOTICE</b></p> <p>When the unit is not in use for an extended period, detach the electrical plug from the AC outlet.</p> 
100 V	117 V	220 V													
240 V	240 V														

# 1 Checking Supplied Items

Check the following to make sure that you received all the items that were shipped along with the unit.

- |                          |     |                                     |     |
|--------------------------|-----|-------------------------------------|-----|
| • Power Cord             | : 1 | • Thermal transfer ribbon cartridge | : 1 |
| • Blade (Carbide)        | : 1 | • Blade Holder                      | : 1 |
| • Roller Base            | : 1 | • Cutter Tool                       | : 1 |
| • Material for Test Cuts | : 1 | • Alignment Tool                    | : 1 |
| • Head Cleaner           | : 1 | • Cleaning Sheet for Printing Head  | : 1 |
| • Hexagonal Screw Driver | : 1 | • User's Manual                     | : 1 |

## 2 Part Names and Functions

### 2-1 Front View

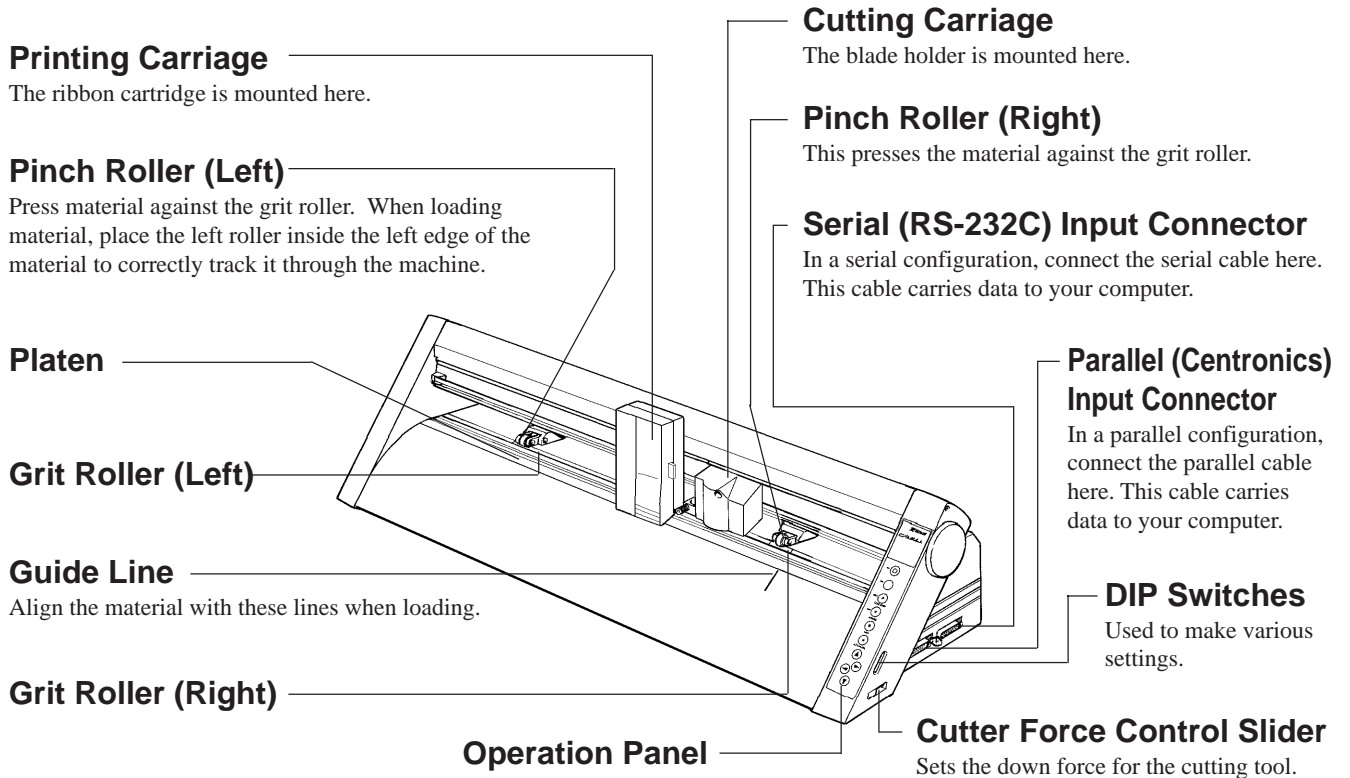

### 2-2 Rear View

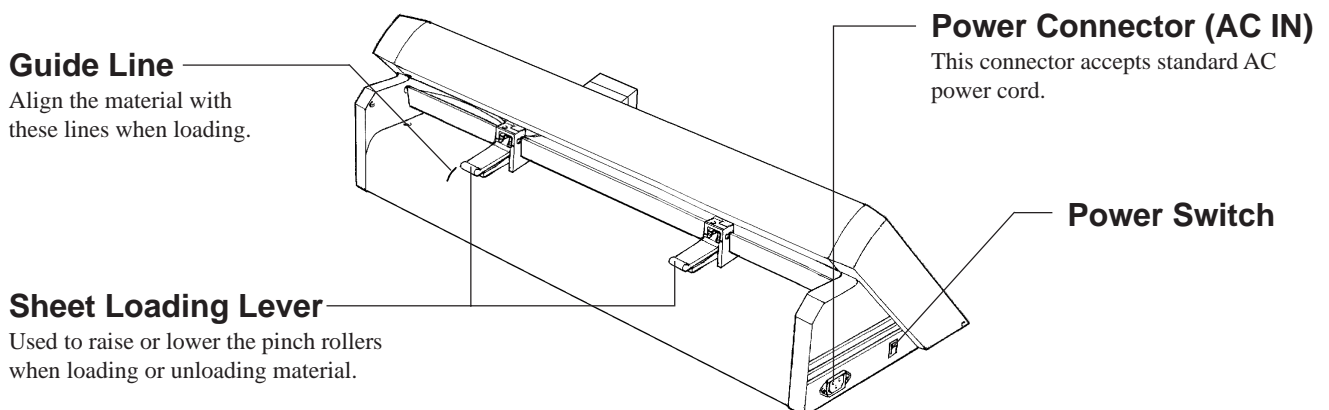

## 2-3 Operation Panel

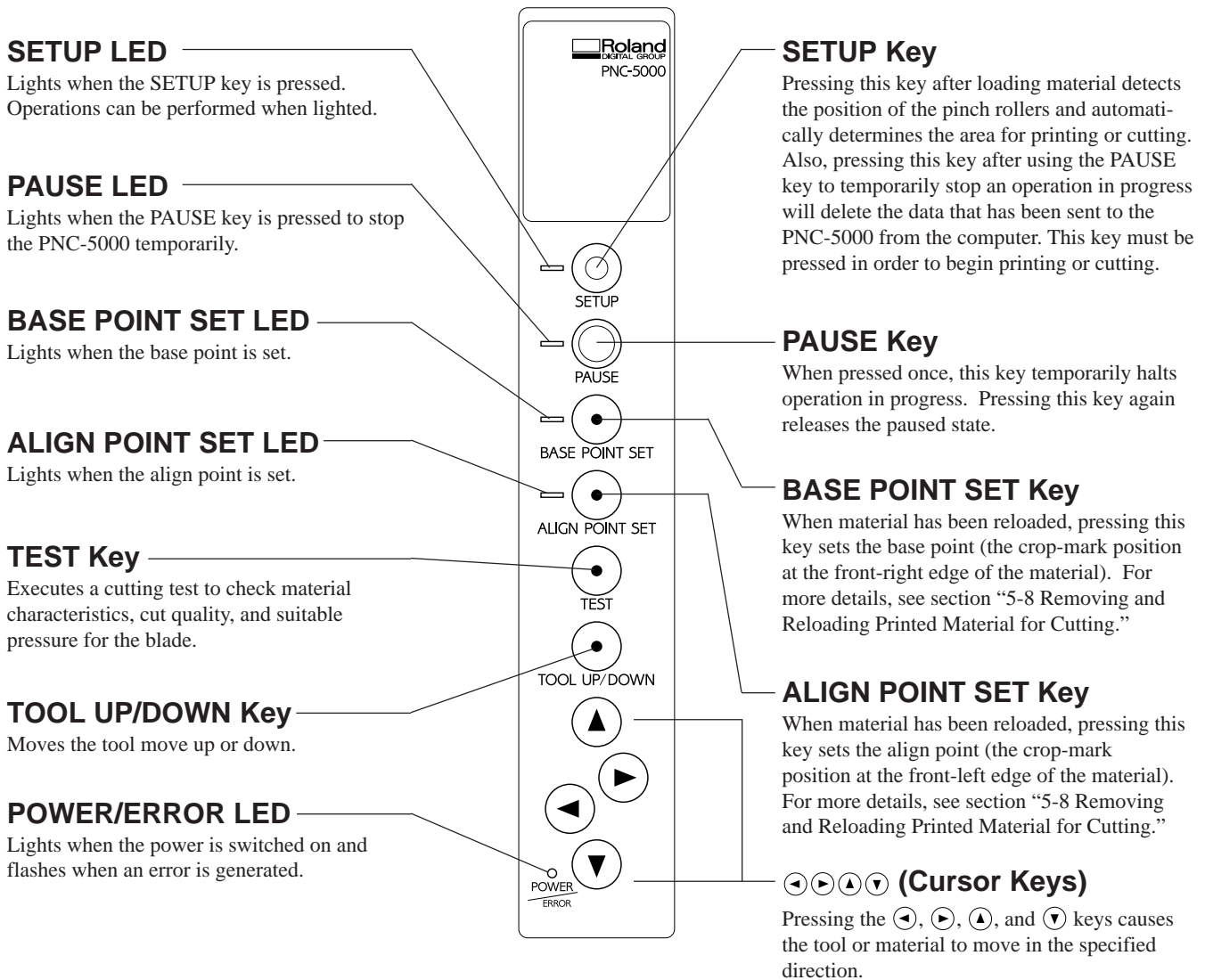

### The SETUP LED and POWER/ERROR LED blink simultaneously.

The SETUP LED and POWER/ERROR LED blink simultaneously if material is not loaded correctly. See "5-5 Loading/Removing Material" for an explanation of how to load material.

### The PAUSE LED and POWER/ERROR LED blink simultaneously.

The PAUSE LED and POWER/ERROR LED blink simultaneously if no ribbon cartridge is installed, or if the ink ribbon has run out. For more details, see "5-4 Installing a Ribbon Cartridge."

## 3 Set-up and Connections

When arranging setup space for the PNC-5000, make sure you have a space that is at least 905 mm (35-11/16") wide, 500 mm (19-11/16") in depth, and 220 mm (8-11/16") in height. Since the material moves during printing and cutting, make sure the unit is placed on a stable, sturdy surface. Also make sure there is nothing that can block the material at both front and rear.

### NOTICE

- Avoid installing the PNC-5000 in the following conditions, as this may result in damage to the machine.
  - Avoid places subject to strong electrical noise.
  - Avoid excessively dusty or damp places.
  - Never leave the unit in a place that is subject to direct sunlight or extreme temperatures.
  - Because it is normal for this device to emit heat when in operation, never place it in an area with poor ventilation.
- Do not try to pick up or move the PNC-5000 by grasping the top area of the unit. Be sure to use both hands to grip the PNC-5000 securely on the left and right sides.
- Always make sure that the power is off on both the computer and the PNC-5000 whenever any cables are connected or disconnected.
- Ensure that the power supply voltage is within  $\pm 10\%$  of the machine's rated voltage.

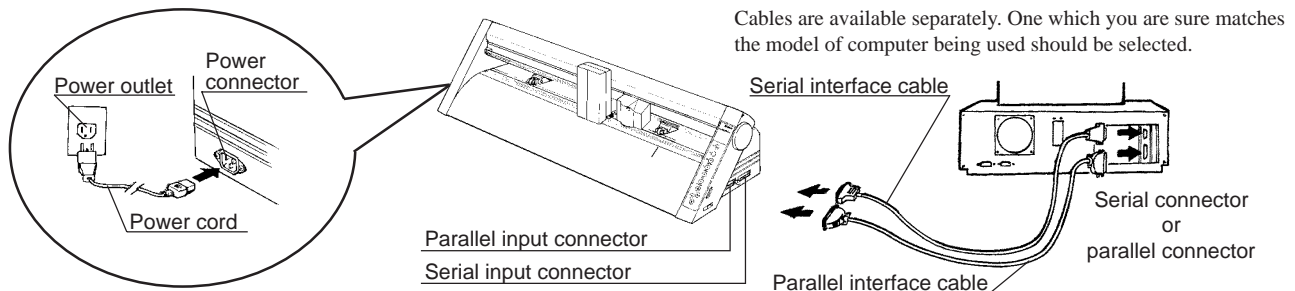

## 4 Here's What the PNC-5000 Can Do

- Print color graphics on vinyl film and other materials.
- Custom cut vinyl film and other materials.
- Print color graphics on vinyl film and other materials, and then immediately custom cut the material.

# 5 Basic Operation

## 5-1 DIP Switch Settings

OFF ↔ ON

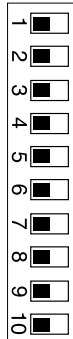

DIP switch	Function	OFF	ON
SW-1	Baud rate	9600	19200
SW-2	Parity	Disable	Enable
SW-3	Parity	ODD	EVEN
SW-4	Handshake	Hardwire	XON/XOFF
SW-5	Front edge sense	Disable	Enable
SW-6	Cut sheet mode	Disable	Enable
SW-7	Blade offset	0.25	0.5*
SW-8	Long output mode	Light	Heavy
SW-9	Crop mark mode	OFF	ON
SW-10	(Not Used)	—	—

\* Option required; please consult your dealer.

### NOTICE

DIP switches settings must be made only when the power is turned off.

All DIP switches are set to OFF when shipped from the factory.

The DIP switches are located on the right face of the unit, near the bottom.

SW-1-4 : Sets the communication parameters for a serial connection. When the PNC-5000 is connected to the computer through the serial port, be sure that the communication parameters for SW-1 to SW-4 are set correctly, matching the computer port settings.

(Data length is fixed to 8 bits.)

SW-5 : Detects automatically the front edge of loaded material. To detect the front edge of loaded material, set SW-5 to ON (enabled).

SW-6 : Detects length of cut material automatically. Switch to ON (enabled) when loading sheet material, and OFF (disabled) when loading roll material.

SW-7 : Sets the amount of offset for the cutter blade. Set to OFF when using a tool with a blade offset of 0.25 mm, or to ON when using a tool with a blade offset of 0.5 mm.

SW-8 : Sets the weight of the material. SW-8, which controls the material weight, should normally be set to OFF (light). Cutting speed slows down when switch is turned ON, but the force used to move the material and the blade increases.

SW-9 : Switch on if wish for crop marks to be printed automatically. Switch off to avoid crop marks.

## 5-2 Powering On

Press the side of the switch marked “|”.

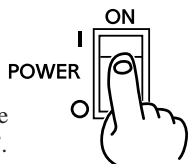

### CAUTION

When the power switch is pressed to power on the unit, the tool carriage moves. Use caution to ensure that your hands or other objects do not become caught in the moving parts.



## 5-3 Installing/Removing a Blade

**NOTICE**

Do not touch the tip of the blade. This could impair the cutting performance of the blade.

### Installation

**1** Insert blade into the blade holder until it snaps into place with an audible click.

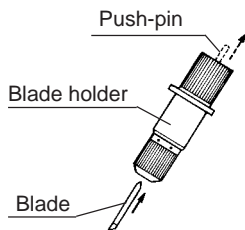

**2** Support the tool-securing screw from below and install the blade holder.

\* Insert the blade holder until the collar is flush with the carriage.

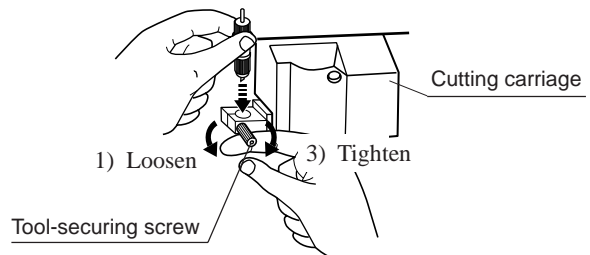

### Adjusting the Cutter Blade

When stock vinyl film is to be cut, tighten the cap all the way (2.5 mm (about 0.1") of blade extension).

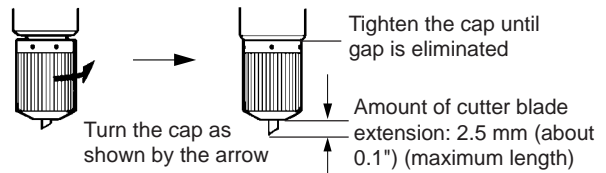

Blade adjustment may be necessary when:

- cutting material whose carrier paper is thinner than the material itself
- cutting material with no carrier paper

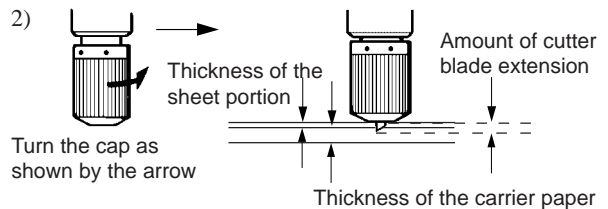
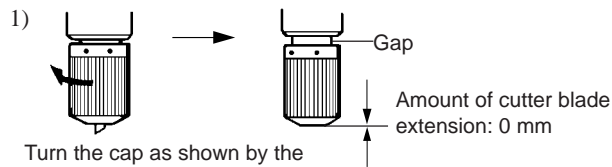

**NOTICE**

When cutting is performed after printing, the cap tip of the blade holder may scratch the printed surface. If this is the case, lengthen the cutter blade extension.

### Removal

**1** 2) Remove the blade holder from the cutting carriage.

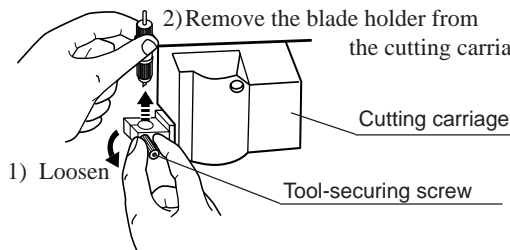

Leave the tool-securing screw loose. Tightening the screw makes it more difficult to install the blade holder.

**2** Press the push-pin and remove the blade from the blade holder.

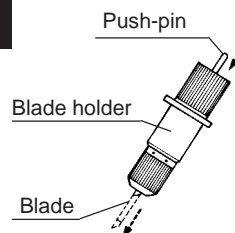

If a blade was used, wipe the blade with a soft cloth to remove any material that may cling to it.

## 5-4 Installing a Ribbon Cartridge

### NOTICE

- A used ribbon cartridge cannot be reused. Do not attempt to turn over and reinstall a used ribbon cartridge, or to rewind the ink ribbon and reuse the cartridge.
- If a single-color ink ribbon has been used for printing, do not attempt to print overtop of this with a four-color ink ribbon or an ink ribbon of a different color.
- Before starting to print, make sure that a ribbon cartridge of the desired color has been installed.

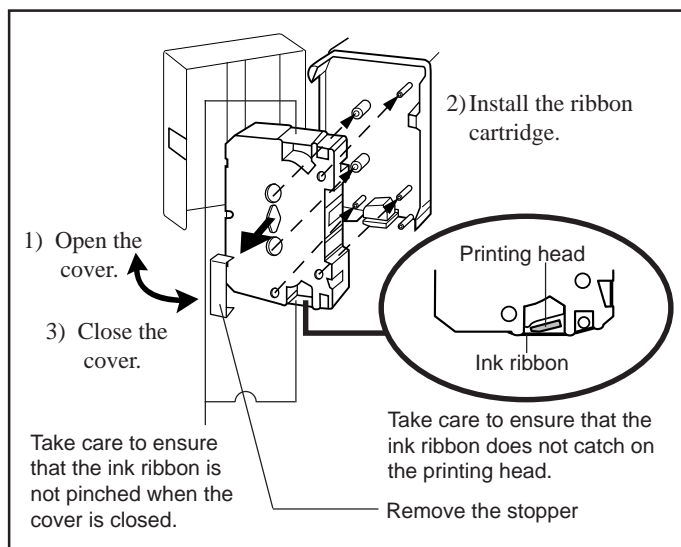

### Remove Excess Slack from the Ink Ribbon

The ink ribbon may show some slack when the stopper has been removed from the ribbon cartridge. If this is the case, the slack should be taken up before the ribbon cartridge is installed.

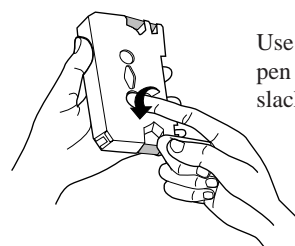

Use your finger or a pen to take up excess slack in the ink ribbon.

### Changing the ribbon cartridge while printing is in progress

- 1) Press the PAUSE key to stop operation of the PNC-5000.
- 2) Remove the ribbon cartridge. → The PAUSE LED and POWER/ERROR LED will blink simultaneously.
- 3) Install the second ribbon cartridge, then press the PAUSE key again.

### If the ink ribbon runs out while printing

- 1) If the ink ribbon runs out during printing, operation stops.  
→ The PAUSE LED and POWER/ERROR LED will blink simultaneously.
- 2) Remove the old ribbon cartridge.
- 3) Install a new ribbon cartridge, then press the PAUSE key. (Be sure to install an ink ribbon of the same type as the old one.)

### If the PAUSE LED and POWER/ERROR LED blink simultaneously

These two LEDs will blink simultaneously if the ink ribbon has been removed, or if the ink ribbon has been used up. In this case, remove the old ink ribbon (if one is present) and install a new ink ribbon, then press the PAUSE key.

## 5-5 Loading/Removing the Material

### Loading the Material

Material with a width (horizontal dimension) of 279.4 mm (11") to 406.4 mm (16") can be loaded.  
Any length (vertical dimension) of 110 mm (4-3/8") or more is acceptable.

#### ▲ CAUTION

- The tool carriage moves when the SETUP key is pressed. Take care to ensure that your hands or other objects do not get caught in the moving parts.
- A soiled material may impair printing accuracy. If dirt or oils from the hand are transferred to the material when it is loaded, use a cloth moistened with alcohol to wipe the material clean before printing.

#### NOTICE

Never move the tool carriage by hand. Damage and poor performance may result.

# 1

- 1) Lower the sheet loading levers to raise the pinch rollers.
- 2) Make sure the right-hand pinch roller is positioned above the right-hand grit roller. If it is not, move the right-hand pinch roller to the right until the two rollers touch.
- 3) Pass the material between the pinch rollers and the grit roller.

\* Before attempting to move the pinch roller, be sure to lower the sheet loading lever.

- 5) Move the left-hand pinch roller to align it with the edge of the materials.

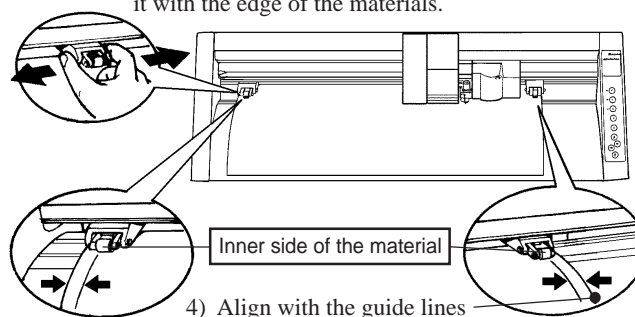

- 4) Align with the guide lines

### When using roll material

- 1) Set the accessory roller base in back of the unit.
- 2) Pass the end of the material between the pinch rollers and the grit rollers so that it extends from the front of the unit.

\* Place the Roller base parallel to the unit.

Pull out the length to be used from the roll material

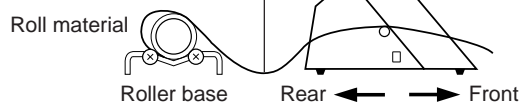

# 2

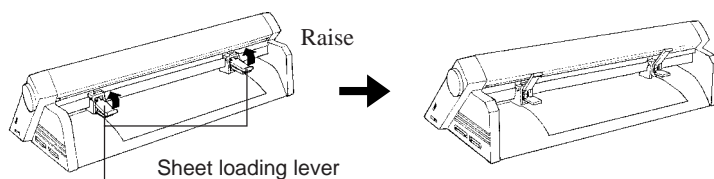

# 3

Press the SETUP key.

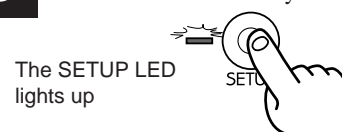

## Removal

\* To remove a portion that has been print or cut on roll material, use the cutter tool included with the PNC-5000.

# 1

Press the SETUP key.

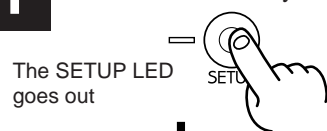

The carriage moves to the left edge of the printing/cutting area.

# 2

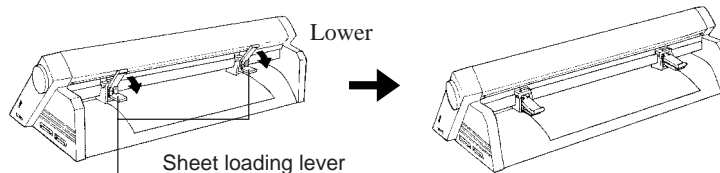

Remove the material.

## 5-6 Downloading Printing/Cutting Data



The unit will begin printing/cutting when it receives printing/cutting data sent from the computer.  
For further details, refer to the user's manual provided with your software.

## 5-7 Pausing Operations

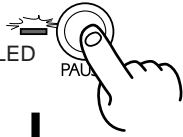
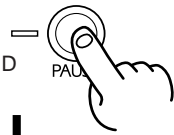
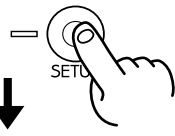
If you want to stop the PNC-5000 momentarily while it is printing or cutting, follow the procedure described below.

<p><b>1</b> Press the PAUSE key.</p> <p>The PAUSE LED lights up</p>  <p>Printing or cutting is paused.</p>	<p><b>2</b> To resume printing or cutting</p> <p>Press the PAUSE key.</p> <p>The PAUSE LED goes out</p>  <p>Printing or cutting resumes.</p>	<p><b>To Terminate printing or cutting</b></p> <p>1) Halt transmission of printing or cutting instructions from the computer. 2) Press the SETUP key.</p> <p>The SETUP LED goes out</p>  <p>Printing or cutting instructions already sent from the computer to the PNC-5000 are deleted, and operation stops.</p>
---	---	--

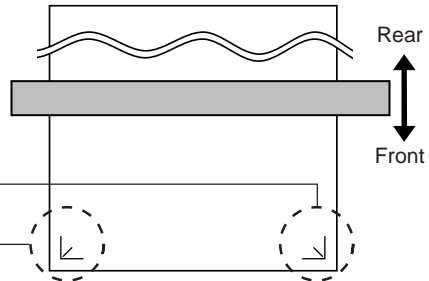
## 5-8 Removing and Reloading Printed Material for Cutting

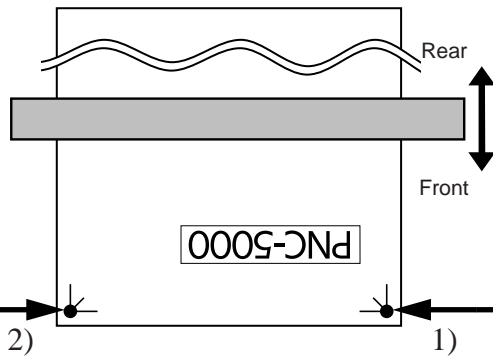
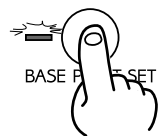
<p><b>1</b></p> <p>Switch off the power, and set DIP switch SW-9 to ON.</p> 	<p><b>3</b> Send the printing data from the computer.</p> <p>Before data output begins, two crop marks are automatically printed on the left and right areas at the front edge of the material.</p> 	
<p><b>2</b></p> <p>Switch on the power, load the alignment tool, ribbon cartridge, and material, then press the SETUP key. (The alignment tool is installed on the cutting carriage in the same way as a blade holder.)</p>	<p><b>4</b> When printing is finished press the SETUP key, remove the material and carry out lamination (or whatever further processing needs to be done). When done, reload the material in the same position used for printing, and press the SETUP key. (The SETUP LED goes out.)</p>	
<p><b>5</b></p> <p>2) Set the align point Use the cursor keys to move the tip of the alignment tool to the square crop mark at the lower left area of the material, then press the ALIGN POINT SET key. The ALIGN POINT SET LED lights up</p> 		<p>1) Set the base point Use the cursor keys to move the tip of the alignment tool to the square crop mark at the lower right area of the material, then press the BASE POINT SET key. The BASE POINT SET LED lights up</p> 
<p><b>6</b></p> <p>Remove the alignment tool from the cutting carriage and install a blade.</p>	<p><b>7</b></p> <p>Send the cutting data from the computer.</p>	



**NOTICE**

When reloading material, be sure to make the settings described above. Crop marks or other marks that have been set with application software cannot be used.

## 5-9 Cutting Test to Check Cutter Force

Before cutting, you may wish to perform a “cutting test” to learn whether the unit cut satisfactorily. If cutting is to be continued on the same material, there is no need to perform a cutting test.

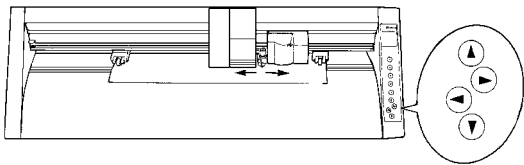
Move the cutter force control slider all the way to the left (minimum cutter force).

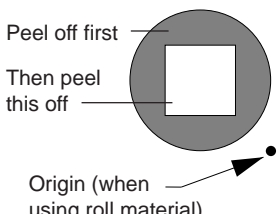
<p><b>1</b></p>  <p>Use the ▲, ▼, ◀, and ▶ keys to move the tool carriage to the position on the material where the cutting test is to be executed.</p> <p>* Note that an area of approximately 2 square centimeters (a little less than a square inch) is required to make a test cut.</p>	<p><b>2</b></p> <p>Press the TEST key.</p>  <p>↓</p> <p>Cutting test starts.</p>
<p><b>3</b></p> <p>1) First peel off the round section (shaded as shown ).</p> <p>→ When it can be peeled by itself, without disturbing the square, the cutter force is set appropriately.</p> <p>2) Next, peel off the square, and look at the backing behind it.</p> <p>→ The optimum blade pressure is correct if you can clearly make out the lines left by the blade.</p> <p>Adjust the cutter force control slider until results as shown above are obtained. (Gradually increase the cutter force until you reach the optimum level.)</p>	 <p>Peel off first —</p> <p>Then peel this off —</p> <p>Origin (when using roll material) —</p>

## 5-10 Performing a Self-test

The PNC-5000 is equipped with a “self-test” function to allow you to check whether or not it is capable of operating normally. If the PNC-5000 is not performing correctly, follow the steps below to perform a self-test.

A computer is not required in order to carry out the self-test.

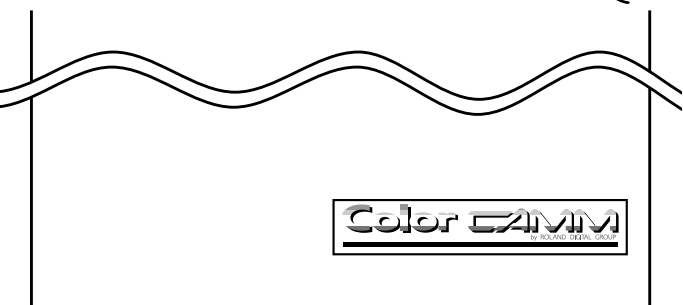
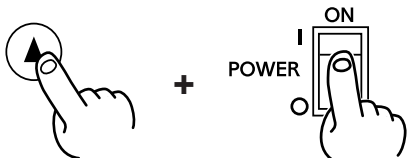
<p><b>1</b></p> <p>Install a blade and ribbon cartridge in the PNC-5000. Performing a cutting test.</p>	<p><b>3</b></p> <p>Load the material, and press the SETUP key.</p>  <p>Operations is normal if the figure shown at below.</p> 
<p><b>2</b></p> <p>Hold down the ▲ key on the panel while you turn the power on.</p> 	

## 5-11 Powering Off

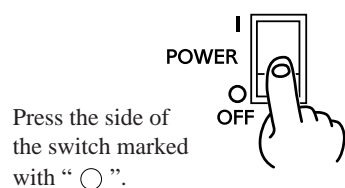

### NOTICE

- Do not switch off the power while the printing head is lowered. Doing so may damage the head and impair printing performance.

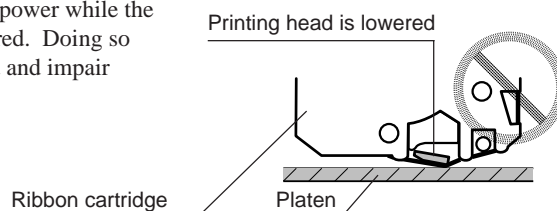

- When the unit is not in use, keep the pinch rollers raised. The pinch rollers may be deformed if left engaged.
- If you do not intend to use the unit for an extended period of time, disconnect the unit from the power outlet.

# 6 Printing and Cutting Samples

## Removing the blank space surrounding a picture

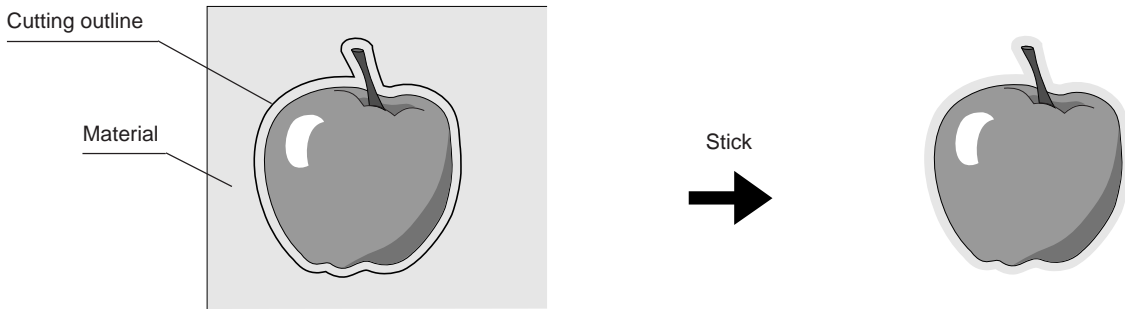

## Adding color to a border

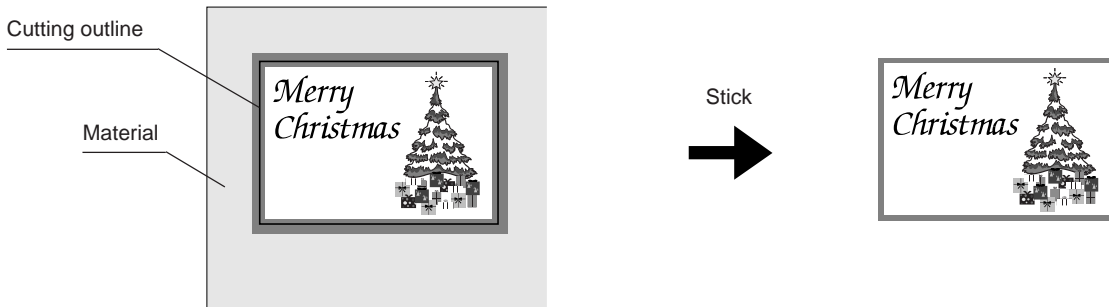

## Correcting Line Pitch

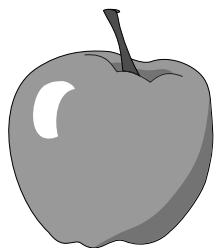

Line pitch: Correct

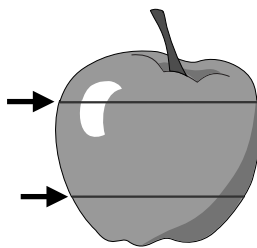

Line pitch is too narrow, and ink overlaps.

Line-pitch correction:  
Set to "Wide" or "Extra Wide"

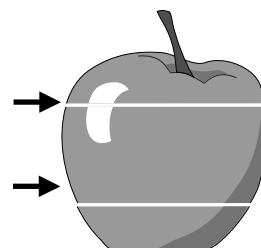

Line pitch is too wide, and spaces appear between lines.















Line-pitch correction:  
Set to "Narrow" or "Extra Narrow"

### How to Correct Line Pitch

Hold down the SETUP key and switch on the power.

Pressing the ▲ or ▼ key changes the pattern in which the PAUSE LED, BASE POINT SET LED, and ALIGN POINT SET LED light up. This pattern indicates the current line pitch. Use the table at right as a reference to press the ▲ and ▼ keys and make the desired line-pitch setting. After making the setting, press the SETUP key (the SETUP LED will light up). (If material is not loaded, be sure to load one before pressing the SETUP key.) The setting that has been made is stored in memory even after the power is switched off. To change the setting, simply repeat the procedure just described.

\* Distance accuracy cannot be guaranteed when line-pitch correction has been performed.

Line-pitch correction	Extra wide	Wide	Default (no correction)	Narrow	Extra narrow
LED display pattern	Lighted  PAUSE	Blinking  PAUSE	Dark  PAUSE	Dark  PAUSE	Dark  PAUSE
	Dark  BASE POINT SET	Blinking  BASE POINT SET	Lighted  BASE POINT SET	Blinking  BASE POINT SET	Dark  BASE POINT SET
	Dark  ALIGN POINT SET	Dark  ALIGN POINT SET	Dark  ALIGN POINT SET	Blinking  ALIGN POINT SET	Lighted  ALIGN POINT SET

## Printing with a width of 210 mm or more (using a 4-color ribbon cartridge)

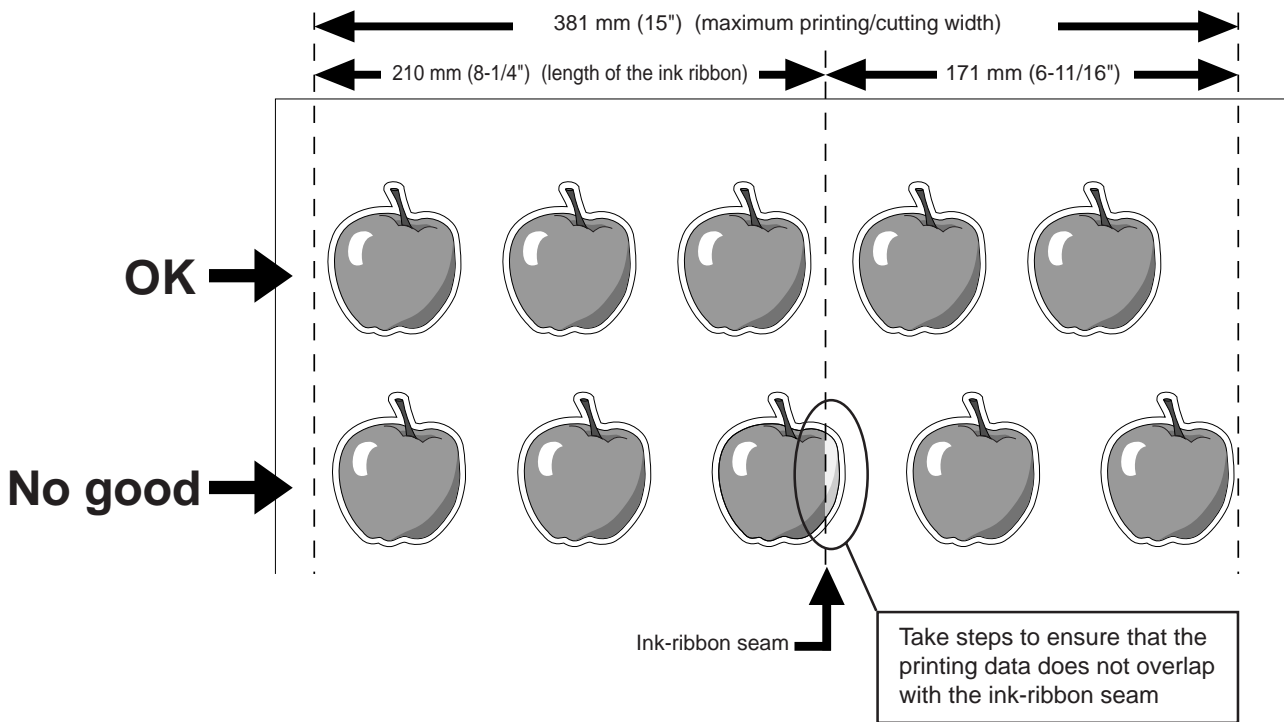

## 7 About the Printing/Cutting Area

### Factory default

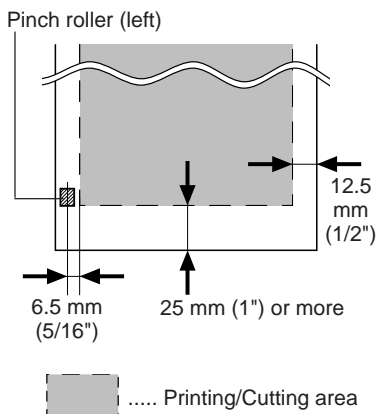

### When DIP switch SW-5 (front edge sense) is ON (enabled)

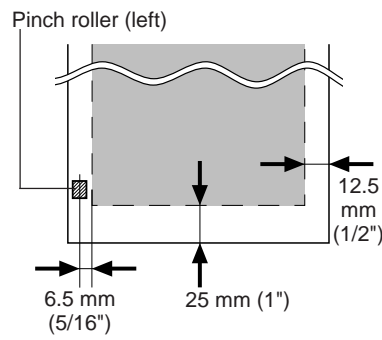

### When DIP switch SW-6 (cut sheet mode) is ON (enabled)

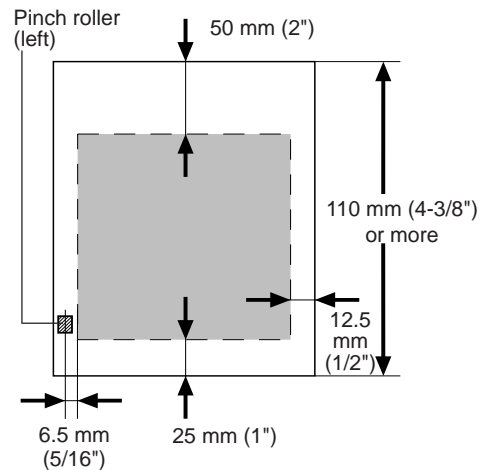

## 8 About the Blade

### If the blade becomes dull

When the blade starts to lose its sharpness, try gradually increasing the cutter force. Increasing the cutter force temporarily allows the blade to perform better. However, once the blade is dull, it is time to replace it.

### Average blade life

The life of a blade varies, depending on the amount of cutting it performs. The total cutting length can vary considerably, depending on the thickness, toughness, and type of adhesive of the cut material. Set an appropriate cutter force, one that is well matched to the material and the hardness of the blade. This will extend the life of the blade. Excessive cutter forces can cause the blade to wear out quickly. Care should be taken.

# 9 Care and Maintenance

**NOTICE**

- Be sure to turn off the power to the PNC-5000 before cleaning.
- Never attempt to oil or lubricate the mechanism.

## Cleaning the main unit

For routine cleaning, use a soft piece of cloth.

## Cleaning the printing head

**NOTICE**

Drops of cleaning fluid may spray out when the cap is opened. Hold away from the platen when opening the cap. The platen may be discolored by any cleaning fluid that comes in contact with it. (The cleaning fluid is non-toxic.)

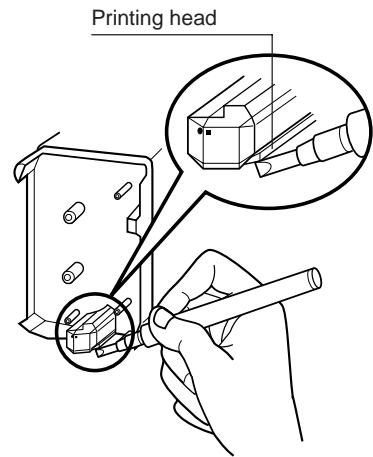

Open the cover and remove the ribbon cartridge.

To remove any soiling on the printing head, use a head cleaner included with the PNC-5000. After cleaning, refer to “5-10 Performing a Self-test” to check operation and make sure that the PNC-5000 is working correctly.

\* If high-quality printing is desired, the printing head should always be kept clean to prevent buildup of grime.

## Cleaning the platen

If the platen becomes soiled, wipe it clean with a dry, soft cloth.

Do not wipe with a head cleaner or alcohol.

Use care when cleaning to avoid damaging the surface of the platen. Damage to the platen may impair the accuracy of printing.

# 10 What to Do If...

If you want to completely stop the operation of the PNC-5000, turn off the power switch.

If the PNC-5000 doesn't run...		
<b>PNC-5000</b>	Is the PNC-5000 power on?	Turn on the power. (See “5-2 Powering On” .)
	Is the unit in SETUP status (the SETUP LED is lit)?	If the SETUP LED is not illuminated, make sure the material is loaded correctly and press the SETUP key to illuminate the SETUP LED.
	Is the PAUSE LED illuminated?	If the PAUSE key has been pressed and the PAUSE LED is lighted, the unit has been paused (see “5-7 Pausing Operations” ). To resume printing or cutting, press the PAUSE key again. The PAUSE LED is extinguished, and printing or cutting resumes. To terminate printing or cutting, first stop the transmission of printing or cutting instructions from the computer to the PNC-5000. Then press the SETUP key. This deletes the printing or cutting instructions that have already been sent from the computer to the PNC-5000, and printing or cutting is stopped. If operation is still not correct when the next batch of data is sent after printing or cutting, or cutting has been stopped, switch the power off and then on again.
	If connected via the serial port, do the communication parameters for the PNC-5000 match those of the computer?	Set the DIP switches correctly (see “5-1 DIP Switch Settings” .)
<b>Computer</b>	Is the computer set up correctly?	Check the following items: <ul style="list-style-type: none"> <li>• DIP switches      • Memory switches      • Interface board</li> <li>• Communication parameters      • Other settings</li> </ul> Read the computer user’s manual and set it up correctly.



<b>Connection cable</b>	Are the computer and the PNC-5000 linked with the right cable?	The type of cable you need is determined by your computer and the software you are using. Even if the computer is the same, running different software may require a different cable. Use the cable specified in your software.
	Is the cable making a secure connection?	Connect securely. (See “3 Set-up and Connections” .)
<b>Software</b>	Is the OS set up correctly?	Check the following items: <ul style="list-style-type: none"> <li>• Output port selection</li> <li>• Output port open</li> <li>• Other settings</li> <li>• Output device selection</li> <li>• Communication parameters</li> </ul> Check the OS user’s manual and set it up correctly.
	Are the application software settings correct?	Check the following items: <ul style="list-style-type: none"> <li>• Output device specifications (select a device name that matches the instruction system. If the wrong device is selected an incorrect instruction may be output, resulting in an error).</li> <li>• Communication parameters</li> <li>• Other settings</li> </ul> Check the software user’s manual and set it up correctly.
	Are the settings for the driver software correct?	If you are using driver software for output on the PNC-5000, then make the settings for the correct driver in the computer. Select the PNC-5000 as the output device.

### Clean, attractive printing is impossible

Is the printing head dirty?	Clean the printing head (see “9 Care and Maintenance”).  <div style="border: 1px solid black; padding: 5px; width: fit-content;"> <p><b>NOTICE</b></p> <p>If cleaning will not improve the printing quality, the printing head might reach to the end of its life. Contact your dealer for replacement of the printing head.</p> </div>
Is the surface of the platen dirty or scratched?	Clean the platen (see “9 Care and Maintenance”).
Is the material dirty?	Remove superficial soiling, then load the material.
Is the material damaged?	Clean, attractive printing is not possible if the material is damaged or warped. Use care to keep materials from being damaged while in storage.

### The Material is not cut properly

Are the blade and blade holder installed correctly and securely?	Install these so that there is no looseness (see “5-3 Installing/Removing a Blade” ).
Is the blade chipped?	If it is, replace it with a new one (see “5-3 Installing/Removing a Blade” ).
Check if there are any dirty deposits on the blade.	If dirty, remove and clean the blade.
Make sure you are using an appropriate cutter force setting.	Perform a “cutting test,” then adjust the cutter force slider as necessary to obtain the optimum cutter force (see “5-9 Cutting Test to Check Cutter force”).
When cutting a thick material, set DIP switch SW-7 to ON (heavy). (See “5-1 DIP Switch Settings” .)	

**The material slips away from the pinch rollers during operation**

<p>Are the sheet loading levers on both the left and right sides raised?</p>	<p>If a sheet loading lever has not been raised, then the material has not been secured in place. Make sure that the pinch rollers on the left and right sides are within the boundaries of the material, and raise the sheet loading levers. (See “5-5 Loading/Removing the Material” .)</p>
<p>Make sure the material is parallel with the grit roller. If the front edge of the material rests at an angle, cut off the odd-shaped part to make it straight. Then align it so that it is parallel with the grit roller.</p>	
<p>If the material is to be advanced over a long distance, moving the movable pinch roller inward slightly can help prevent the material from becoming dislodged. Also, after loading the material, it is recommended that you carry out an alignment test by using the ⬆ key to advance the material by the amount that will be used for printing or cutting. Make sure that the material travels correctly through the machine.</p>	
<p>If roll material is used, print or cut only after first pulling out the amount of material that is to be used. The PNC-5000 is not designed to pull material off rolls.</p>	
<p>Make sure that the left and right edges of the material do not touch the inner surfaces of the PNC-5000 during operation. Such contact may damage the material, and could also make it impossible to advance the material—thus causing it to slip.</p>	

**The POWER/ERROR LED is blinking**

<p>Are the application software settings correct?</p>	<p>Check the following items:</p> <ul style="list-style-type: none"> <li>• Output device specifications (select a device name that matches the instruction system. If the wrong device is selected an incorrect instruction may be output, resulting in an error).</li> <li>• Communication parameters      • Other settings</li> </ul> <p>Check the software user’s manual and set it up correctly.</p>
<p>If connected via the serial port, do the communication parameters for the PNC-5000 match those of the computer?</p>	<p>Set the DIP switches correctly (see “5-1 DIP Switch Settings” .)</p>

**PAUSE LED and POWER/ERROR LED blink simultaneously**

<p>Is the ribbon cartridge installed correctly?</p>	<p>Install the ribbon cartridge correctly on the printing carriage (see “5-4 Installing a Ribbon Cartridge”).</p>
<p>Has the ink ribbon been used up?</p>	<p>If there is no more ink ribbon left for printing, replace the ribbon cartridge with a new one (see “5-4 Installing a Ribbon Cartridge”).</p>

**SETUP LED and POWER/ERROR LED blink simultaneously**

<p>Is the material loaded correctly? Does the front of the material stick out to the front surface of the PNC-5000? Is the length of the loaded material too short?</p>	<p>Load the material correctly (see “5-5 Loading/Removing the Material”).</p>
---	---

